



STOCK PRODUCTS

04-2024

LEDSTRIPS

IN STOCK



9,6 W/m



14,4W/m



20,2W/M

Colour	Power/m	Length	Width	Input	Lm/m	LED/m	Cutttable Length	Ref.	€
2700K	9,6W/m	5m	8mm	DC 24V	1170	140	50mm	T14.140-5M-2700K	65,00
3000K	9,6W/m	5m	8mm	DC 24V	1270	140	50mm	T14.140-5M-3000K	65,00
4000K	9,6W/m	5m	8mm	DC 24V	1300	140	50mm	T14.140-5M-4000K	65,00
2700K	14,4W/m	5m	10mm	DC 24V	1740	210	33,3mm	T14.210-5M-2700K	90,00
3000K	14,4W/m	5m	10mm	DC 24V	1880	210	33,3mm	T14.210-5M-3000K	90,00
4000K	14,4W/m	5m	10mm	DC24V	1940	210	33,3mm	T14.210-5M-4000K	90,00
2700K	20,2W/m	5m	10mm	DC 24V	2700	224	33,3mm	T14.224-5M-2700K	160,00
3000K	20,2W/m	5m	10mm	DC 24V	2790	224	33,3mm	T14.224-5M-3000K	160,00
4000K	20,2W/m	5m	10mm	DC24V	2885	224	33,3mm	T14.224-5M-4000K	160,00

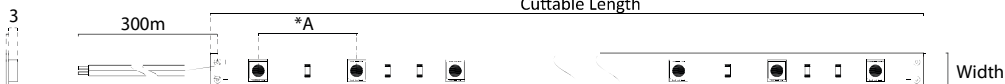

LEDSTRIPS COB



Colour	Power/m	Length	Width	Input	Lm/m	LED/m	Cuttable Length	Ref.	€
2700K	14,4W/m	5m	10mm	DC 24V	1300	504	41,6mm	T14.504-5M-2700K	110,00
3000K	14,4W/m	5m	10mm	DC 24V	1350	504	41,6mm	T14.504-5M-3000K	110,00
4000K	14,4W/m	5m	10mm	DC 24V	1400	504	41,6mm	T14.504-5M-4000K	110,00



PROFIPLUS

IN
STOCK



P3-1



P4-1



P5-1



P6-2

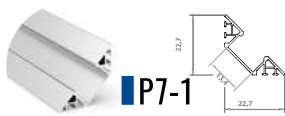

P7-1



P17-2

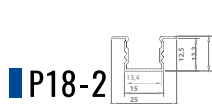

P18-2



P22-3



P25-3

	Colour	Length	€ ■	€ □	€ ■	Cover opal
P3-1	■	2M	19,00			8,00
P4-1	■ □ ■	2M	11,00	17,00	17,00	8,00
P4-1	■ □ ■	3M	16,00	25,00	25,00	12,00
P5-1	■ □ ■	2M	11,00	17,00	17,00	8,00
P5-1	■ □ ■	3M	16,00	25,00	25,00	12,00
P6-2	■ □ ■	2M	12,00	19,00	19,00	8,00
P6-2	■ □ ■	3M	18,00	28,00	28,00	12,00
P7-1	■ □ ■	2M	17,00	25,00	25,00	8,00
P17-2	■	2M	89,00			8,00
P18-2	■ □ ■	2M	18,00	26,00	26,00	8,00
P22-3	■	2M	54,00			18,00
P25-3	■ □ ■	2M	38,00	49,00	49,00	15,00

24V-DRIVERS

IN STOCK



LPV - 24

	W	IP	A	Input	Output	(l x b x h) Dimensions	Ref.	€
Meanwell Driver 20	20W	IP67	0,84A	100-240V	24V	120x35x26	L02.LPV-20-24	19,00
Meanwell Driver 35	35W	IP67	1,50A	100-240V	24V	150x40x30	L02.LPV-35-24	26,00
Meanwell Driver 60	60W	IP67	2,50A	100-240V	24V	165x43x33	L02.LPV-60-24	30,00
Meanwell Driver 100	100W	IP67	4,50A	100-240V	24V	190x52x37	L02.LPV-100-24	49,00
Meanwell Driver 150	150W	IP67	4,50A	100-240V	24V	195x64x40	L02.LPV-150-24	70,00

HLG - 24

	W	IP	A	Input	Output	(l x b x h) Dimensions	Ref.	€
Meanwell Driver 100H	100W	IP67	4,00A	100-240V	24V	220 x 68x 38,8	L02.HLG-100H-24B	115,00
Meanwell Driver 120H	120W	IP67	5,00A	100-240V	24V	220 x 68 x 38,8	L02.HLG-120H-24B	115,00
Meanwell Driver 150H	150W	IP67	6,30A	100-240V	24V	220x68x38,8	L02.HLG-150H-24B	112,00
Meanwell Driver 240H	240W	IP67	10,00A	100-240V	24V	244,2x68x38,8	L02.HLG-2400H-24B	146,00

ELG DALI - 24

	W	IP	A	Input	Output	(l x b x h) Dimensions	Ref.	€
ELG-75	75W	IP67	3,15A	100-240V	24V	180x35x63	L02.ELG-75-24DA-3Y	80,00
ELG-100	120W	IP67	4,00A	100-240V	24V	199x35x63	L02.ELG-100-24DA-3Y	93,00
ELG-150	150W	IP67	6,25A	100-240V	24V	219x35x38,8	L02.ELG-150-24DA-3Y	104,00
ELG-200	200W	IP67	8,40A	100-240V	24V	244,2x37x71	L02.ELG-200-24DA-3Y	131,00
ELG-240	240W	IP67	10,00A	100-240V	24V	244,2x37x71	L02.ELG-200-24DA-3Y	117,00

E27

IN
STOCK



	W	Lm	Color	Input	Dim.	Ref.	€
1 E27 Std	8W	900 Lm	2700K	220-240V	Dim	F02.8204232	10,00
2 E27 Globe Dia 95	6W	750 Lm	2500K	220-240V	Dim	F02.8204240	12,00
3 E27 Globe Dia 195	6W	710 Lm	2500K	220-240V	Dim	F02.8204239	14,00
4 E27 Edison Dia 64	4W	440 Lm	2500K	220-240V	Dim	F02.8204242	9,00
5 E27 Amber Dia 45	5W	400 Lm	2200K	220-240V	Dim	F02.8204251	13,00
6 E27 Amber Dia 60	5W	400 Lm	2200K	220-240V	Dim	F02.8204252	13,00

* Dimmable



	W	Lm	Color	Input	Ref.	€
SMD-10W	10W	1080	3000K	175-250V	L14.10042	4,00
SMD-10W	10W	1080	4000K	100-250V	L14.10041	4,00

GU10

IN
STOCK



	W	Lm	Color	Beam	Ref.	€
Gu10 Par16	7,5W	600lm	2700K	38°	L14.10220	6,00
Gu10 Par16 Dim	7,5W	600lm	2700K	38°	L14.10224	10,00
Gu10 Par16	7,5W	620lm	3000K	38°	L14.10221	6,00
Gu10 Par16 Dim	7,5W	620lm	3000K	38°	L14.10225	10,00

SWAP S

IN
STOCK



	W	IP	CT	Flux	⊕	Color	Ref.	€
Swap S	5W	IP20	3000K	700	62	□	A03.A2121111W	61,00
Swap S	7W	IP20	3000K	940	62	□	A03.A2121211W	71,00
Swap S DIM PH.CUT	7W	IP20	3000K	940	62	□	A03.A2121221W	83,00

*incl bezel



Ø 62-78

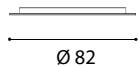

Ø 82

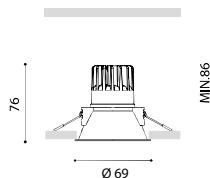

SWAP M

IN
STOCK



	W	IP	CT	Flux	Ⓡ	Color	Ref.	€
Swap M	5W	IP20	2700K	675	75	□	A03.A2122110W	62,00
Swap M	5W	IP20	3000K	700	75	□	A03.A2122111W	62,00
Swap M	7W	IP20	2700K	910	75	□	A03.A2122210W	73,00
Swap M	7W	IP20	3000K	940	75	□	A03.A2122211W	73,00
Swap M DIM.PH.CUT	7W	IP20	2700K	910	75	□	A03.A2122220W	84,00
Swap M DIM.PH.CUT	7W	IP20	3000K	940	75	□	A03.A2122221W	84,00
								€
Swap M	7W	IP20	2700K	910	75	■	A03.A2122210N	84,00
Swap M	7W	IP20	3000K	940	75	■	A03.A2122211N	84,00
Swap M DIM.PH.CUT	7W	IP20	2700K	910	75	■	A03.A2122220N	97,00
Swap M DIM.PH.CUT	7W	IP20	3000K	940	75	■	A03.A2122221N	97,00

*incl bezel

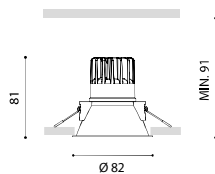
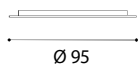

SWAP IP 65

IN
STOCK



	W	IP	CT	Flux		Color	Ref.	€
Swap S	7W	IP65	3000K	910	62	□	A03.A2121211W65	83,00
Swap M	5W	IP65	3000K	700	75	□	A03.A2122111W65	74,00
Swap M	7W	IP65	3000K	940	75	□	A03.A2122211W65	84,00
Swap M	5W	IP65	3000K	700	75	■	A03.A2122111N65	86,00
Swap M	7W	IP65	3000K	940	75	■	A03.A2122211N65	98,00

Swap S

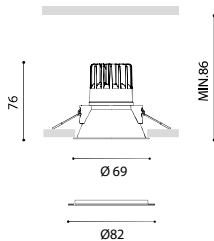

Ø 62-78

Swap M

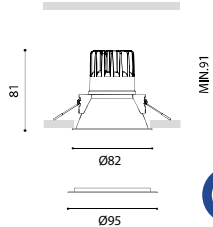

Ø 75-91

SATURN



	Ⓟ	Color	Ref.	€
Saturn Fix	60-65	<input type="checkbox"/> <input checked="" type="checkbox"/>	F02.4014270	10,00
Saturn Tilt	70-75	<input type="checkbox"/> <input checked="" type="checkbox"/>	F02.4014280	12,00

Excl Lightbulb incl Fitting (see page 6)

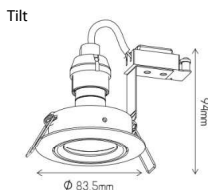
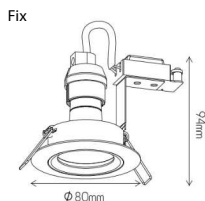

*GU10

- (RAL 7021)
- (RAL 9010)

Niet Dimbaar 6,00
Dimbaar 10,00

BARI Q

IN
STOCK

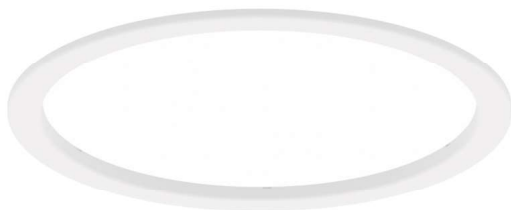

	W	IP	CT	Flux	Ⓜ	Dia	Color	Ref.	€
Bari Q	11W	IP44	3000K	1480	135	155mm	□	P08.EU001.1111.830.A000	64,00
Bari Q	11W	IP44	4000K	1510	135	155mm	□	P08.EU001.1111.840.A000	64,00
Bari Q	16W	IP44	3000K	2040	135	155mm	□	P08.EU002.1111.830.A000	64,00
Bari Q	16W	IP44	4000K	2090	135	155mm	□	P08.EU002.1111.840.A000	64,00
Bari Q	17W	IP44	3000K	2410	205	225mm	□	P08.EU003.1111.830.A000	68,00
Bari Q	17W	IP44	4000K	2460	205	225mm	□	P08.EU003.1111.840.A000	68,00
Bari Q	22W	IP44	3000K	2950	205	225mm	□	P08.EU004.1111.830.A000	68,00
Bari Q	22W	IP44	4000K	3020	205	225mm	□	P08.EU004.1111.840.A000	68,00

Accessories : Surface mounting housing

Bari Q LED Surface mounting housing	□	ØF=155mm H=75mm	P08.FLO30.11.0155	39,00
Bari Q LED Surface mounting housing	□	ØF=255mm H=79mm	P08.FLO30.11.0225	39,00

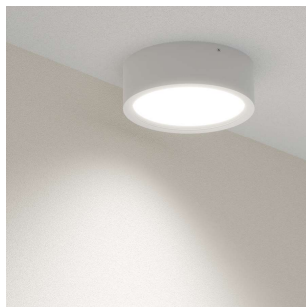

ART 100

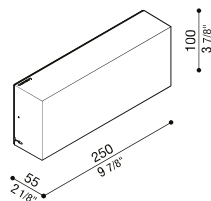

	W	IP	CT	Input	Lm	Color	Ref.	€
Art 100	10W	IP66	3000K	220-240V	800lm	□	L08.LL1160003	82,00
Art 100	10W	IP66	4000K	220-240V	800lm	□	L08.LL116000N	82,00

ART 250

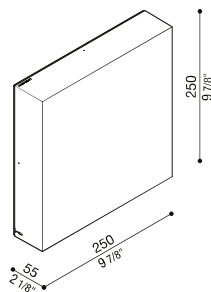

	W	IP	CT	Input	Lm	Color	Ref.	€
Art 250	20W	IP66	3000K	220-240V	1650lm	□	L08.LL1161003	117,00
Art 250	20W	IP66	4000K	220-240V	1650lm	□	L08.LL116100N	117,00

KAMELEON



	W	IP	CT	Dimensions	Lm	Ref.	€
Kameleon Round	10W 13W 16W	IP20	3000K 4000K 5700K	235mm	1000lm - 1650lm	HVP.KAM10-16CCT R	44,00
Kameleon Round SENSOR	10W 13W 16W	IP20	3000K 4000K 5700K	235mm	1000lm - 1650lm	KAMELEON-SENS-3CCT	126,00

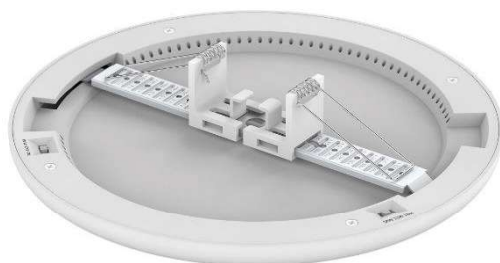

TREND



TREND 60

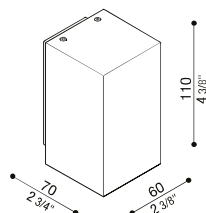

	w	iP	CT	Input	Lm	Color	Ref	€
Trend 60	3W	IP66	3000K	220-240V	500lm	■	L08.LL1290023	136,00

TREND 60 U&D

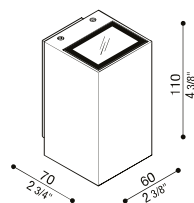

	W	iP	CT	Input	Lm	Color	Ref.	€
Trend 60 U&D	6W	IP66	3000K	220-240V	1000lm	■	L08.LL1291023	171,00

■ (RAL 7021)

AGO



AGO GARDEN

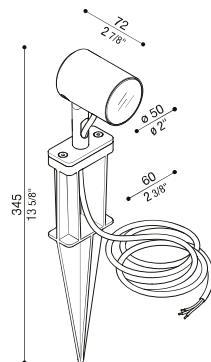
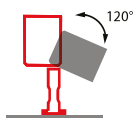

W IP CT Input Lm Color Ref. €

Ago Garden 6W IP66 3000k 220-240V 568Lm ■ LL126001M34 167,00
INCL 5M CABLE

AGO WALL

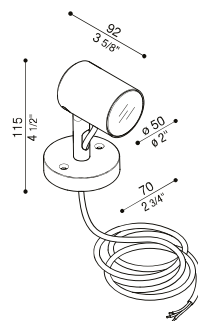
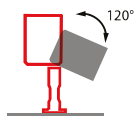

W IP CT Input Lm Color Ref. €

Ago Wall 6W IP66 3000k 220-240V 568Lm ■ L08.LL126005M3 174,00

■ (RAL 9005)

AGO UP

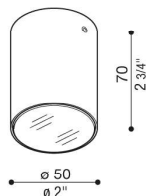

	W	IP	CT	Input	Lm	Color	Ref.	€
Ago Up	5W	IP66	3000k	220-240V	497Lm	■	L08.LL12640BM3	155,00
Ago Up	5W	IP66	3000k	220-240V	497Lm	□	L08.LL12640WM3	155,00

□ (RAL 9010)

■ (RAL 9005)



TAG 110

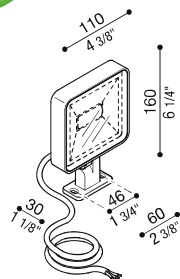

	W	IP	CT	Input	Lm	Color	Ref.	€
TAG 110	10W	IP66	3000K	220-240V	672lm	■	L08.LL1150023	96,00
TAG 110	10W	IP66	4000K	220-240V	672lm	■	L08.LL115002N	96,00

TAG 210

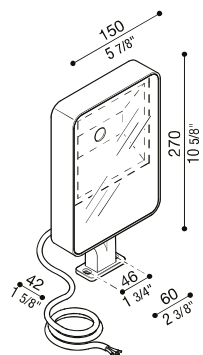

	W	IP	CT	Input	Lm	Color	Ref.	€
TAG 210	25W	IP66	3000K	220-240V	2585lm	■	L08.LL1151023	182,00
TAG 210	25W	IP66	4000K	220-240V	2585lm	■	L08.LL115102N	182,00

■ (RAL 7021)

SIENA

IN
STOCK



	W	IP	CT	Input	Lm	Color	Ref.	€
Siena	18W	IP65	3000K	220-240V	2505lm	□	P08.HM002.1111.830.A000	107,00
Siena	18W	IP65	4000K	220-240V	2630lm	□	P08.HM002.1111.840.A000	107,00

	W	IP	CT	Input	Lm	Color	Ref.	€
Siena Sensor	18W	IP65	3000K	220-240V	2505lm	□	P08.HM002.1111.830.A001	140,00
Siena Sensor	18W	IP65	4000K	220-240V	2630lm	□	P08.HM002.1111.840.A001	140,00

	W	IP	CT	Input	Lm	Color	Ref.	€
Siena Sensor+Nood	18W	IP65	3000K	220-240V	2505lm	□	P08.HM002.1111.830.A101	241,00
Siena Sensor+Nood	18W	IP65	4000K	220-240V	2630lm	□	P08.HM002.1111.840.A101	241,00

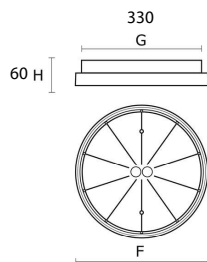

□ (RAL 9010)

SHINE

AVAILABLE
SOON

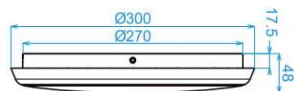

Emergency*
Lumenoutput = 4W = 350 lm

	W	IP	CT	Input	Lm	Sensor	Emergency	Ref.	€
Shine	25W	IP54	3000K	220-240V	2200lm			U01.AL08-12-25W-3	78,00
Shine	25W	IP54	3000K	220-240V	2200lm	•		U01.AL08-12-25W-SS-3	112,00
Shine	25W	IP54	3000K	220-240V	2200lm		•	U01.AL08-12-25W-E-3	112,00
Shine	25W	IP54	3000K	220-240V	2200lm	•	•	U01.AL08-12-25W-E-3	158,00
Shine	25W	IP54	4000K	220-240V	2300lm			U01.AL08-12-25W	78,00
Shine	25W	IP54	4000K	220-240V	2300lm	•		U01.AL08-12-25W-SS	112,00
Shine	25W	IP54	4000K	220-240V	2300lm		•	U01.AL08-12-25W-E	112,00
Shine	25W	IP54	4000K	220-240V	2300lm	•	•	U01.AL08-12-25W-MS	158,00

ALTERNATIVE OPTION IN STOCK = SIENA

SHINE MINI

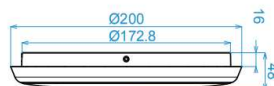

	W	IP	CT	Input	Lm	Ref.	€
Shine mini	12W	IP54	3000K	220-240V	1080lm	U01.AL08-8-12W-3	48,00
Shine mini	12W	IP54	4000K	220-240V	1250lm	U01.AL08-8-12W	

APOLLO IP66

AVAILABLE
SOON



	W	Lm/W	CT	Beam Angle	Lm	Ref.	€
Apollo IP66	100W	160lm/w	4000K	90°	16000lm	S17.XJ-FLE100W-M	255,00
Apollo IP66	150w	160lm/w	4000K	90°	24000lm	S17.XJ-FLE150W-M	330,00
Apollo IP66	200w	160lm/w	4000K	90°	32000lm	S17.XJ-FLE2000W-M	385,00

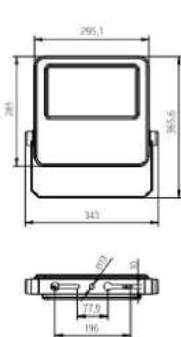

100 w

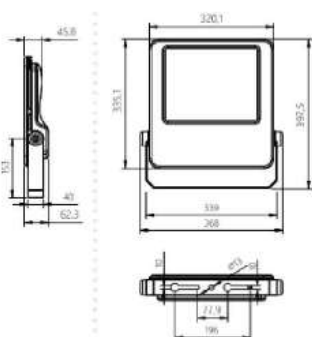

150 w

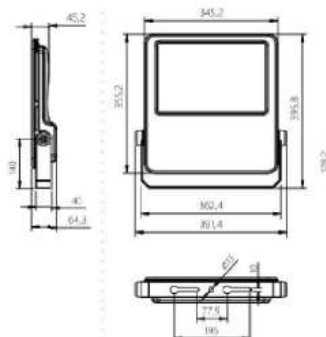

200 w

JOY 2.0

IN
STOCK



	W	IP	CT	Lm	Ref.	€
Joy 2.0	37W	IP66	4000K	5865lm	C01.247643.146	174,00

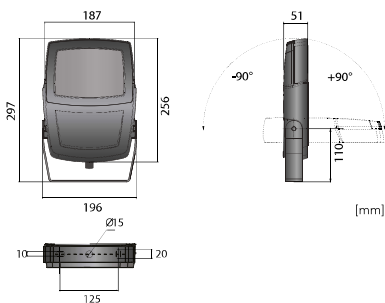

PIXEL AS



	W	IP	CT	Lm	Ref.	€
PIXEL AS	70W	IP66	4000K	10400lm	C01.236643.208	403,00
PIXEL AS	105W	IP66	4000K	15600lm	C01.236643.312	450,00
PIXEL AS	140W	IP66	4000K	20800lm	C01.236643.416	486,00

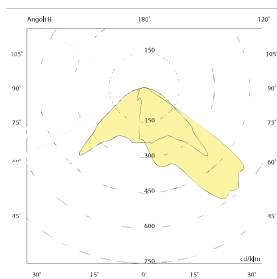
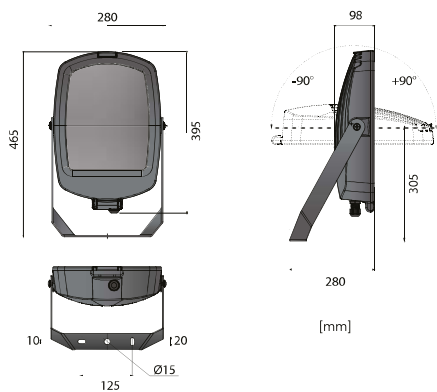



	W	IP	CT	Reflector	Lm	Color	Ref.	€
Artnis	7W	IP20	3000K	33°	722lm	□	L09.8481.71.2	75,00
Artnis	7W	IP20	3000K	33°	722lm	■	L09.1581.71.2	75,00
Artnis	15W	IP20	3000K	33°	1440lm	□	L09.7581.71.2	95,00
Artnis	15W	IP20	3000K	33°	1400lm	■	L09.0681.71.2	95,00
Artnis	27W	IP20	3000K	40°	2902lm	□	L09.6681.71.2	120,00
Artnis	27W	IP20	3000K	40°	2902lm	■	L09.9681.71.2	120,00

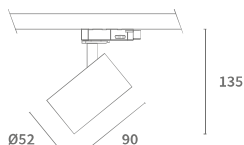

Artnis 7W

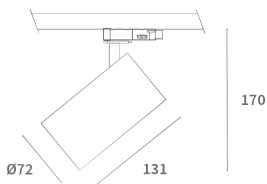

Artnis 15W

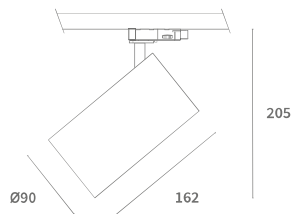

Artnis 27W

STIO



	W	IP	CT	Lm	Color	Reflector	Ref.	€
Stio	22,5W	IP20	3000K	3214lm	□	36°	L09.2.17.4681	120,00
Stio	22,5W	IP20	3000K	3214lm	■	36°	L09.2.17.4682	120,00

MIRROR

IN
STOCK

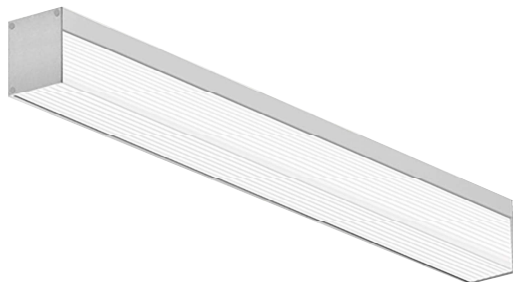

	W	IP	CT	Power	Lm	Color	Ref.	€
Mirror LED	11W	IP44	3000K	220-240V	1350lm	□	P08.AL001.1111.830.A00	95,00
Mirror LED	11W	IP44	3000K	220-240V	1350lm	■	P08.AL001.2211.830.A00	95,00
Mirror LED	11W	IP44	3000K	220-240V	1350lm	■	P08.AL001.3311.830.A00	95,00

Product code

L [mm] W [mm] H [mm]

592

50

60

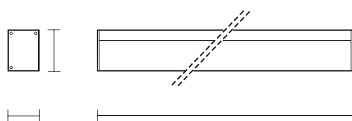

ELEMENT

AVAILABLE
SOON



ASK FOR ALTERNATIVE OPTION IN STOCK = PRATO Q

	W	IP	CT	Input	Lm	lm/w	Ref.	€
ELEMENT 595x595	35W	IP40	3000K	220-240V	3895lm	111lm/W	S02.ELEM-60-3000K	83,00
ELEMENT 595X595	35W	IP40	4000K	220-240V	4006lm	114lm/W	S02.ELEM-60-4000K	83,00

	W	IP	CT	Input	Lm	lm/w	Ref.	€
ELEMENT 295x1195	35W	IP40	3000K	220-240V	3704lm	111lm/W	S02.ELEM-120-3000K	91,00
ELEMENT 295x1195	35W	P40	4000K	220-240V	3950lm	114lm/W	S02.ELEM-120-4000K	91,00

	Ref.	€
SURFACE MOUNTED FRAME 600x600	P08.FL010.11.6060	40,00
SURFACE MOUNTED FRAME 1200x300	P08.FL010.11.1230	46,00
QUICK CONNECTOR PREMOUNTED ON DRIVER	H02.3.01.0117	8,00
DALI DRIVER	S02.ELEM-OPT-DALI	48,00

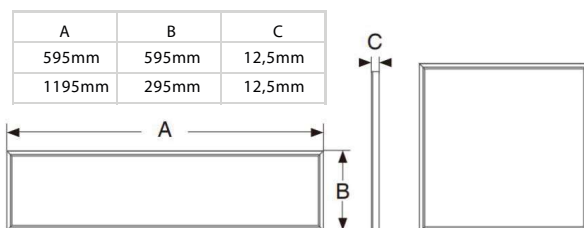

CANNON II

IN
STOCK



	W	IP	CT	Beam Angle	Lm	Lm/W	Ref.	€
Cannon II	200W	IP65	4000K	120°	32550lm	160 lm/W	S14.CANNON II 200W	210,00

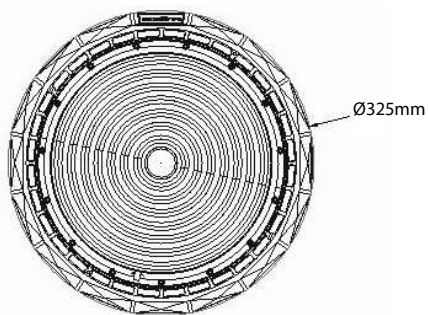
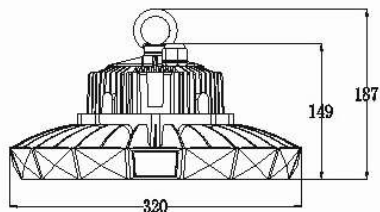

LANUS

IN
STOCK



	W	IP	CT	Beam Angle	Lm	Lm/W	Ref.	€
Lanus Round M	150W	IP65	4000K	90°	24480lm	155 lm/W	T04.106904	164,00

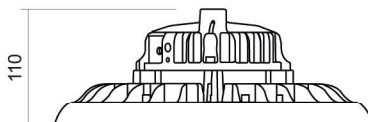
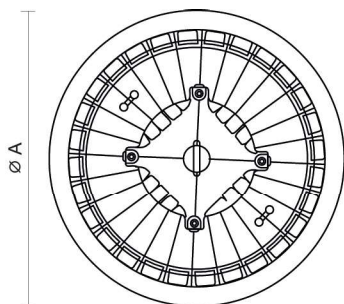

NANOTTICA

IN
STOCK



	W	Lm	lm/W	A	D	Ref.	€
Nanottica 1.4ft PCc 2600/840	16W	2440	152	1175	700-960	T04.100072	81,00
Nanottica 1.4ft PCc 3200/840	20W	2910	146	1175	700-960	T04.100073	81,00
Nanottica 1.4ft PCc 4400/840	27W	4040	151	1175	700-960	T04.100074	83,00
Nanottica 1.4ft PCc 6400/840	38W	5750	159	1175	700-960	T04.100075	86,00
Nanottica 1.5ft PCc 3250/840	20W	3050	156	1455	970-1230	T04.100076	92,00
Nanottica 1.5ft PCc 4000/840	24W	3620	155	1455	970-1230	T04.100077	92,00
Nanottica 1.5ft PCc 5500/840	33W	5020	154	1455	970-1230	T04.100078	94,00
Nanottica 1.5ft PCc 8000/840	45W	7310	162	1455	970-1230	T04.100079	99,00

IP66

* Inox Clips

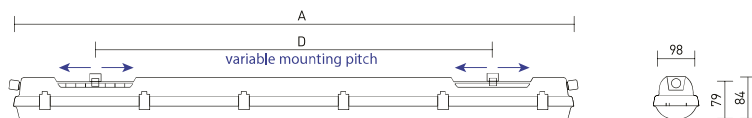

LIGHTLINE



	W	IP	CT	Beam Angle	Lm	input	Ref.	€
Lightline	8W	IP42	3000K	160°	870lm	220-240V	U01.Light-line-8W	39,00
Lightline	18W	IP42	3000K	160°	940lm	220-240V	U01-Light-line-18W	62,00

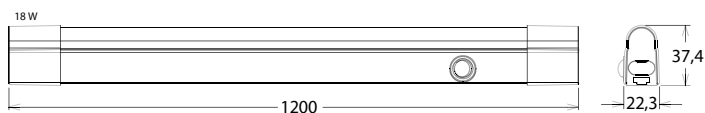
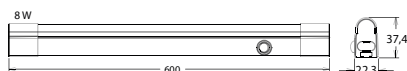

SANI

IN
STOCK



	W	IP	CT	Angle Beam	Lm	Color	Ref.	€
Sani	15W	IP54	3000K	60°	1300lm	□	U01.DL38-15W-D-3W	76,00
Sani	15W	IP54	3000K	60°	1300lm	■	U01.DL38-15W-D-3B	76,00

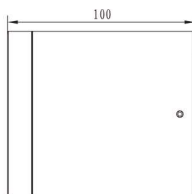
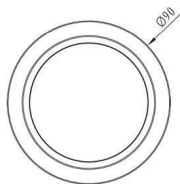



	Color	Ref.	
Siro 1xGU10	<input type="checkbox"/> <input checked="" type="checkbox"/>	U01.SIRO1	30,00
Siro 2xGU10	<input type="checkbox"/> <input checked="" type="checkbox"/>	U01.SIRO2	53,00
Siro 3xGU10	<input type="checkbox"/> <input checked="" type="checkbox"/>	U01.SIRO3	77,00

* Excl.Gu10 See page 6

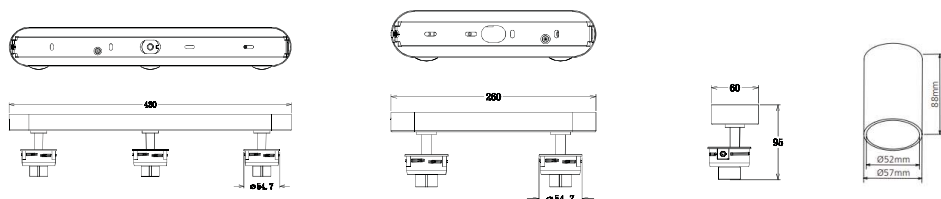

SIGMA II LED



	W	CT	Input	Lm	Color	LxHxW Dimensions	Ref.	€
Sigma II Led	25W	3000K	220-240V	2330lm	□ ■	1085x57x75	P08.AR002.xx11.830.A020	140,00
Sigma II Led	36W	3000K	220-240V	2610lm	□ ■	1625x57x75	P08.AR003.xx11.830.A020	182,00
Sigma II Led	48W	3000K	220-240V	4850lm	□ ■	2170x57x75	P08.AR004.xx11.830.A020	227,00

See accessories p33



SIGMA II ACCESSOIRES



Electrical suspension
Pieces in set: 1

P08.FS002.11.1500	□	22,00
<hr/>		
P08.FS002.33.1500	■	22,00

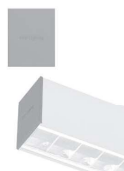

Sigma II End cap PC
Pieces in set : 1

P08.FE004.11.0000	□	3,00
<hr/>		
P08.FE004.22.0000	■	3,00



Sigma Invisible linear Joint Set (2pcs)
Pieces in set : 2

P08.FJ002.00.0000	■	6,00
-------------------	---	------



Simple Suspension
Pieces in Set:1

P08.FS001.00.1500	■	7,00
-------------------	---	------

ONTEC S



Flag AKC.OS06

IP65 1H

	Lens	W	Lm	Mode	Temp.Range		Ref.	€
Ontec S M1	Antipaniek	3W	360	M/NM	10° 40°	Autotest	T13.OS.M1ATM660W	86,00
Ontec S M5	Antipaniek	5W	576	M/NM	10° 40°	Autotest	T13.TM-OS.M5ATM160W	171,00
	Lens	W	Lm	Mode	Temp.Range		Ref.	
Ontec S M2 COLD	Antipaniek	3W	241	NM	-15° 40°	Autotest	T13.TM-OS.M2ATM16CW	142,00
							Ref.	
Recess.Mounting set							T13.TM-AKC.UN000	12,00
Flag Ontec S							T13.TM-AKC.OS06	27,00



M: Maintained
 NM: Non-Maintained

ONTEC C

IN STOCK



IP20 1H

	Lens	W	Lm	Mode		Ref.	€
Ontec C M1	Antipaniek	3w	338	NM	Autotest	T13.TM-OC.M1ATN600W	136,00
Ontec C C1	Vluchtweg	3w	297	NM	Autotest	T13.TM-OC.C1ATN600W	142,00

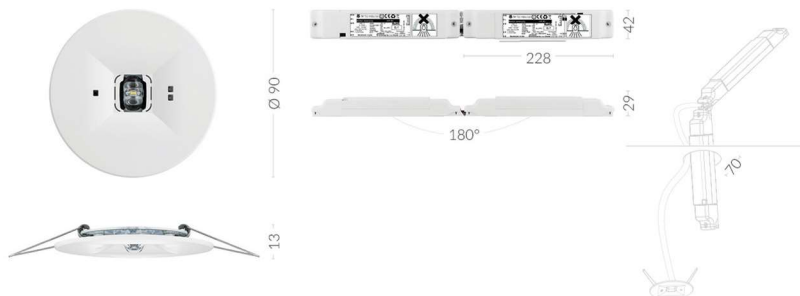

NM: Non-Maintained

ONTEC R

IN STOCK



IP20 1U

	Lens	W	Lm	Mode		Ref.	€
Ontec R M1	Antipaniek	2W	360	NM	Autotest	T13.TM-OR.M1ATN600W	126,00
Ontec R C1	Vluchtweg	2W	306	NM	Autotest	T13.TM-OR.C1ATN600W	132,00

* acc recess. mounting set Ontec R T13.TM-AKC.OR00W 22,00

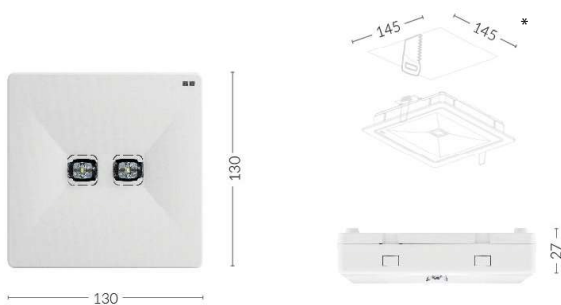

ONTEC G

IN STOCK



IP20 3H

	Lens	W	Lm	Mode		Ref.	€
Ontec G E1E	Antipaniek	2w	>300 cd/m ²	M	Autotest	T13.TM-OG.EEATM800W	148,00
*	acc recess. mounting set Ontec G					T13.TM-AKC.OG00W	22,00





Waregemstraat 200 | B-8540 Deerlijk | Tel. 056/72 97 61
www.hvplighting.com | info@hvplighting.com